

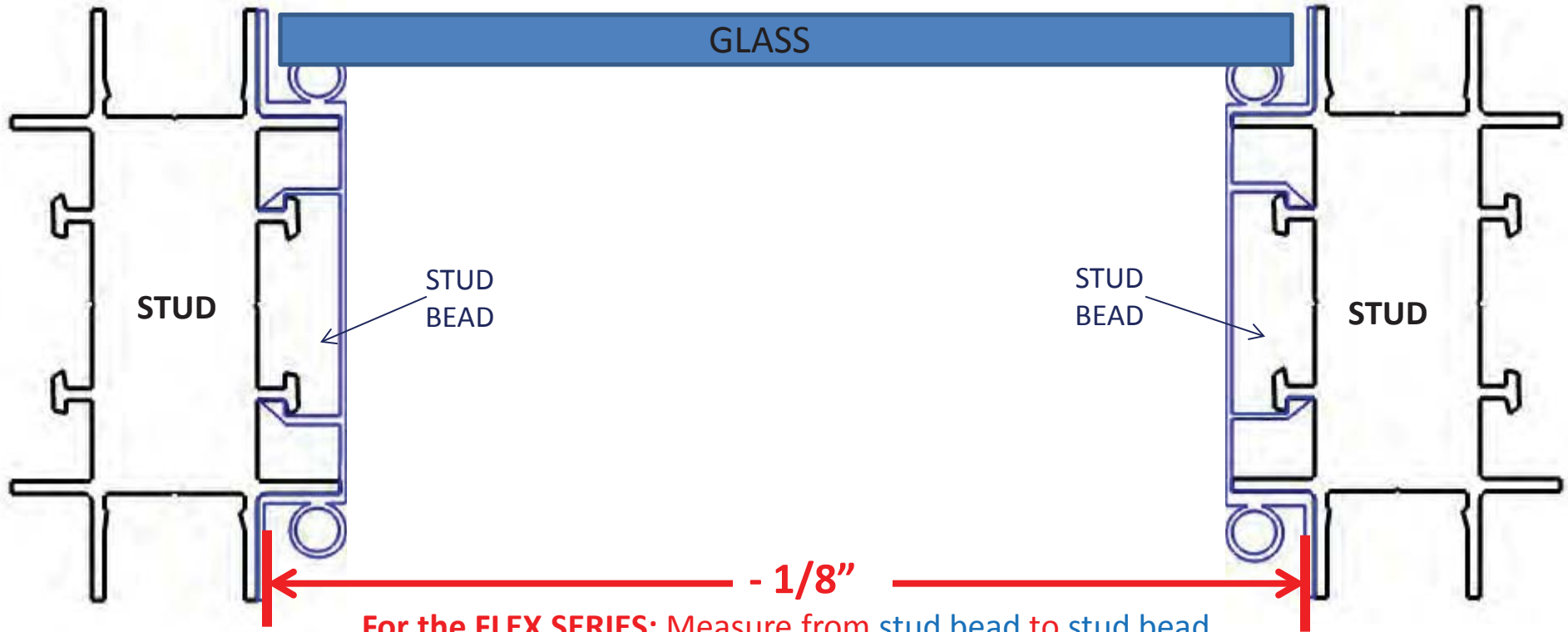

This guide must be used in order to get correct measurements for Flex Series Glass.

GLASS MEASURING GUIDE Flex Series

Measuring Glass For Flex Series



For the **FLEX SERIES**: Measure from stud bead to stud bead then subtract **1/8"** as shown above.

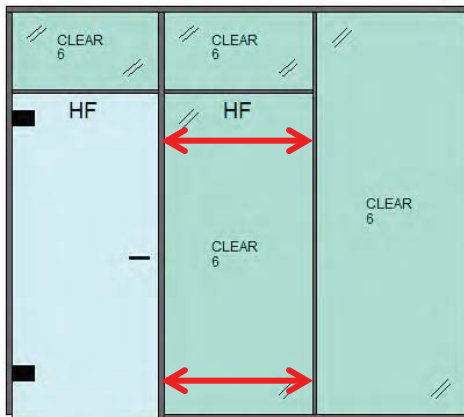

Measuring Track to Stud

When measuring Track to Stud, place your tape at the top of the bottom track and measure up to the stud bead and add $\frac{3}{4}$ " as shown in the picture.

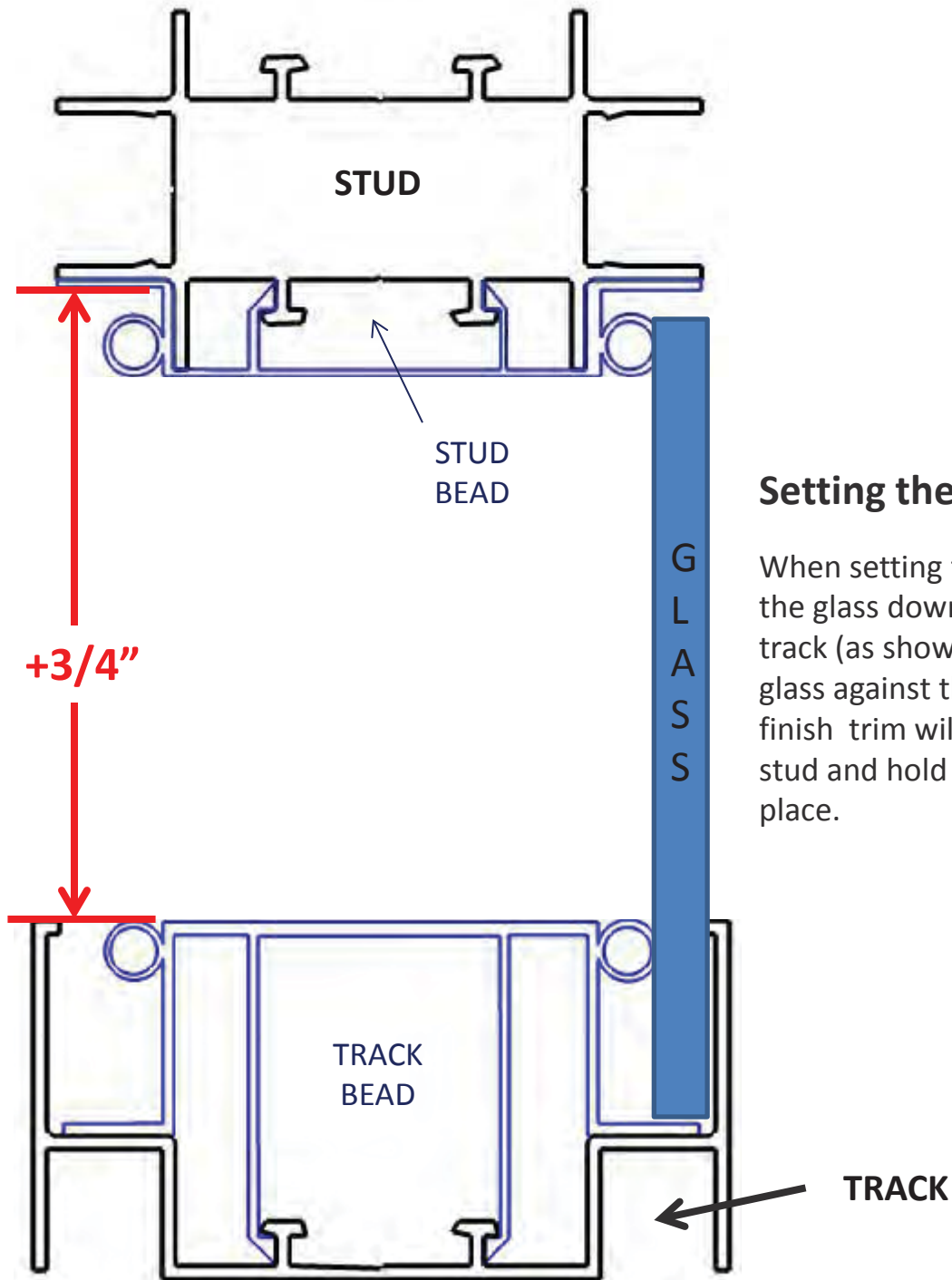
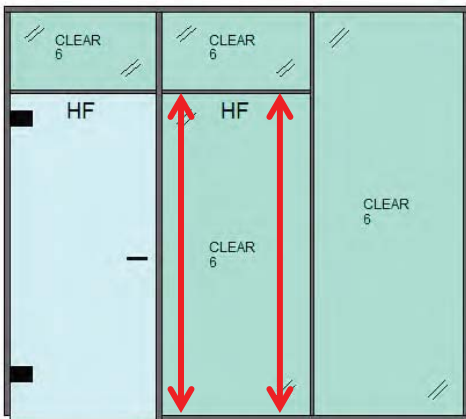

Setting the Glass

When setting the glass: first set the glass down into the bottom track (as shown) and rest the glass against the stud bead. The finish trim will snap into the stud and hold the glass firmly in place.

Clerestory

When measuring a clerestory, place your tape against the stud bead and measure up to the bottom of the top track like shown in picture and add a 1/2".

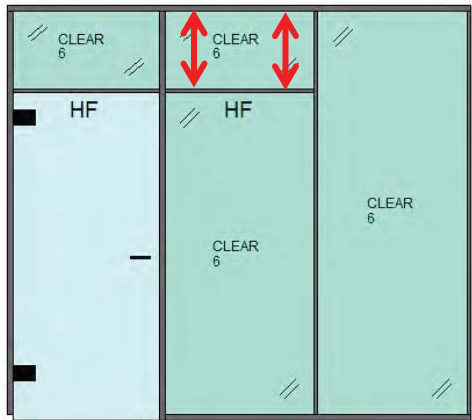
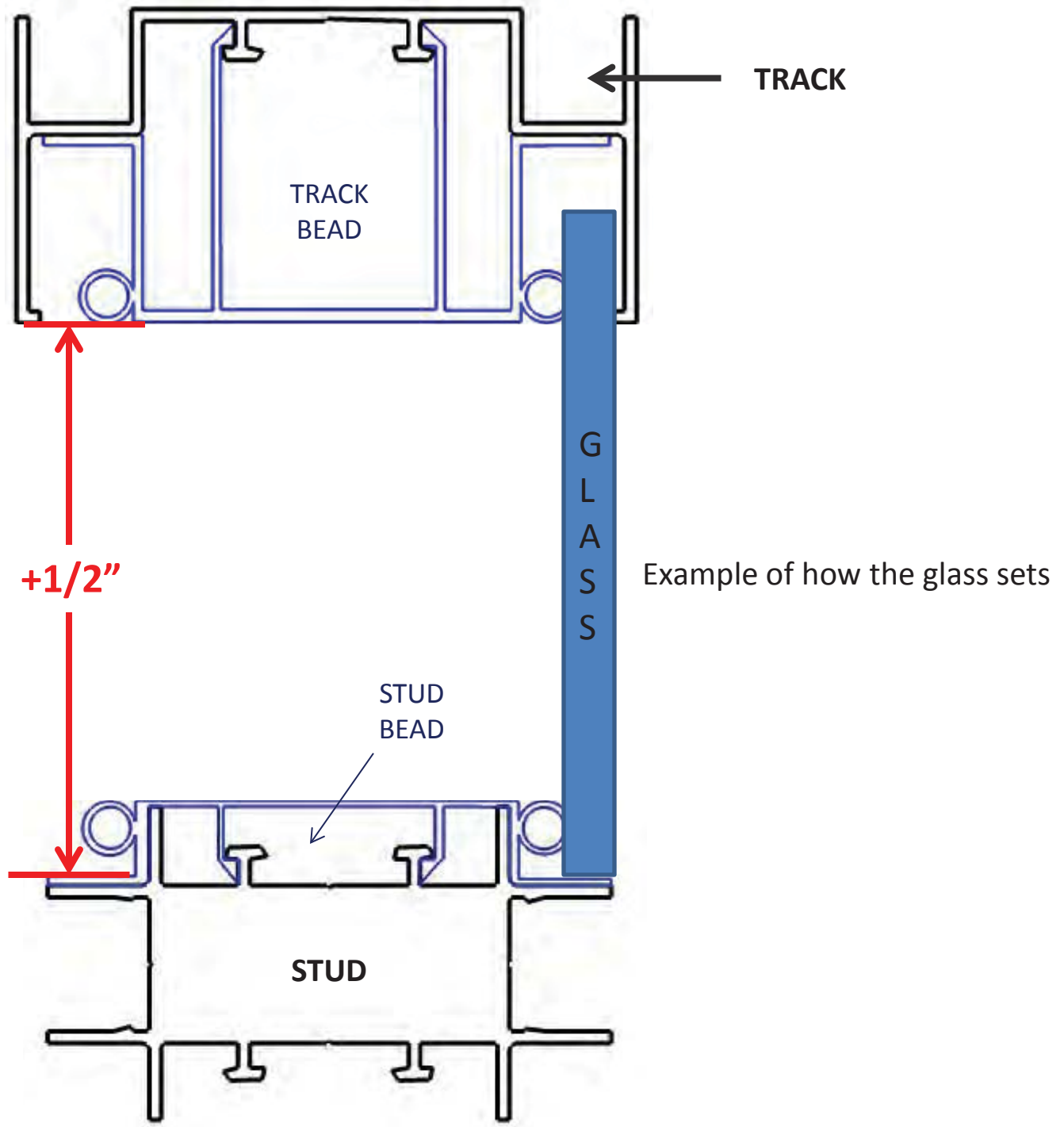

Full Height Glass

Measure the visual opening from the top track to the bottom track and add $\frac{3}{4}$ " like shown in the picture.

When measuring for Flex Series full height glass you will need to measure both sides of your opening and adjust your measurement appropriately.

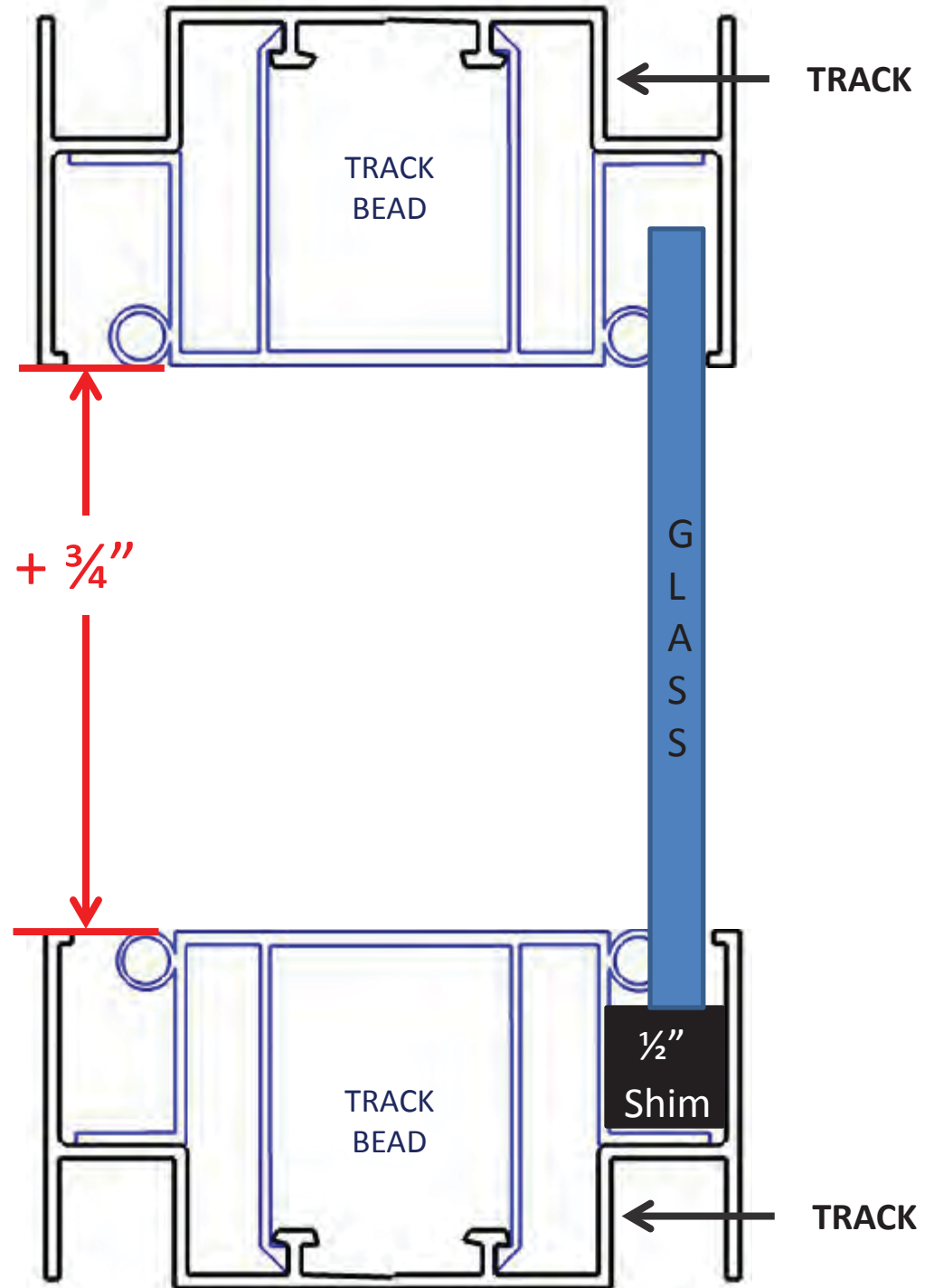
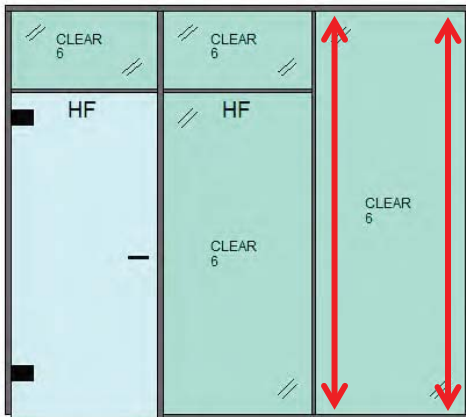

Measuring Guide For All Glass Door Height

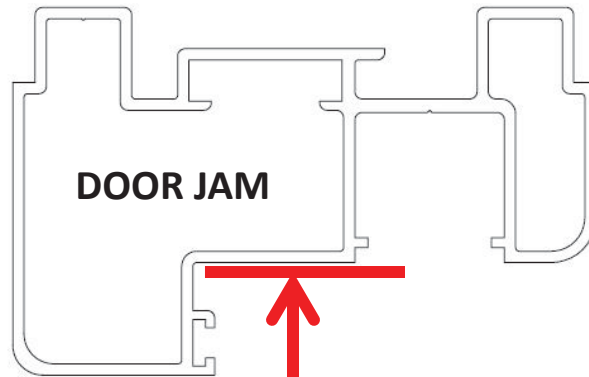

- 3/4"

Floor

When measuring for a glass swing door, measure from the floor the top jamb like shown here and subtract 3/4". This will allow for a 1/4" at the top and 1/2" at the bottom. Be sure to check both sides and adjust accordingly.

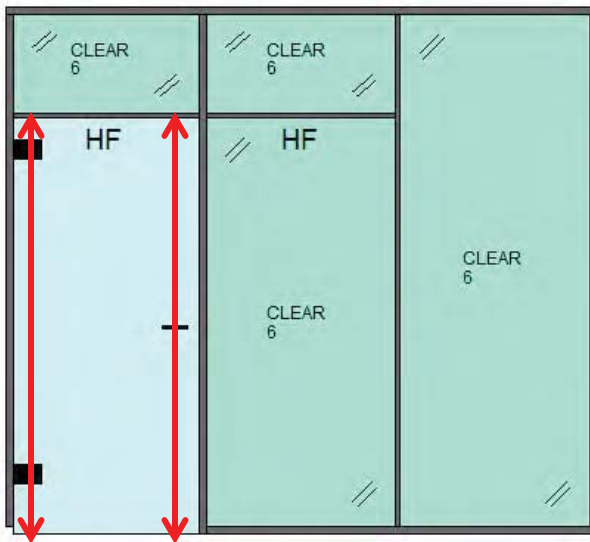

Measuring Guide For All Glass Swing Door

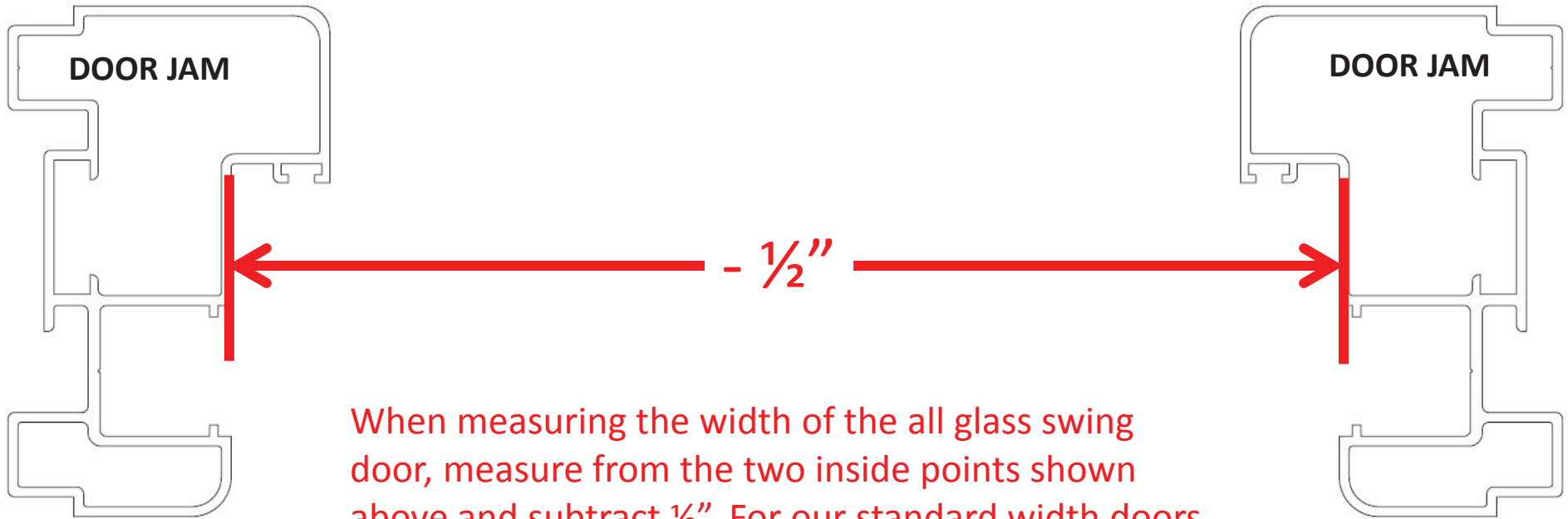

When measuring the width of the all glass swing door, measure from the two inside points shown above and subtract 1/2". For our standard width doors you should get 35 1/2" for a width.

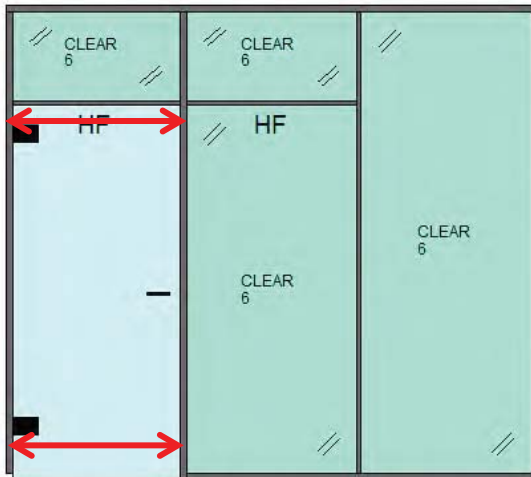



C-RAIL GLASS DOOR MEASUREMENT (GENESIS STUD)

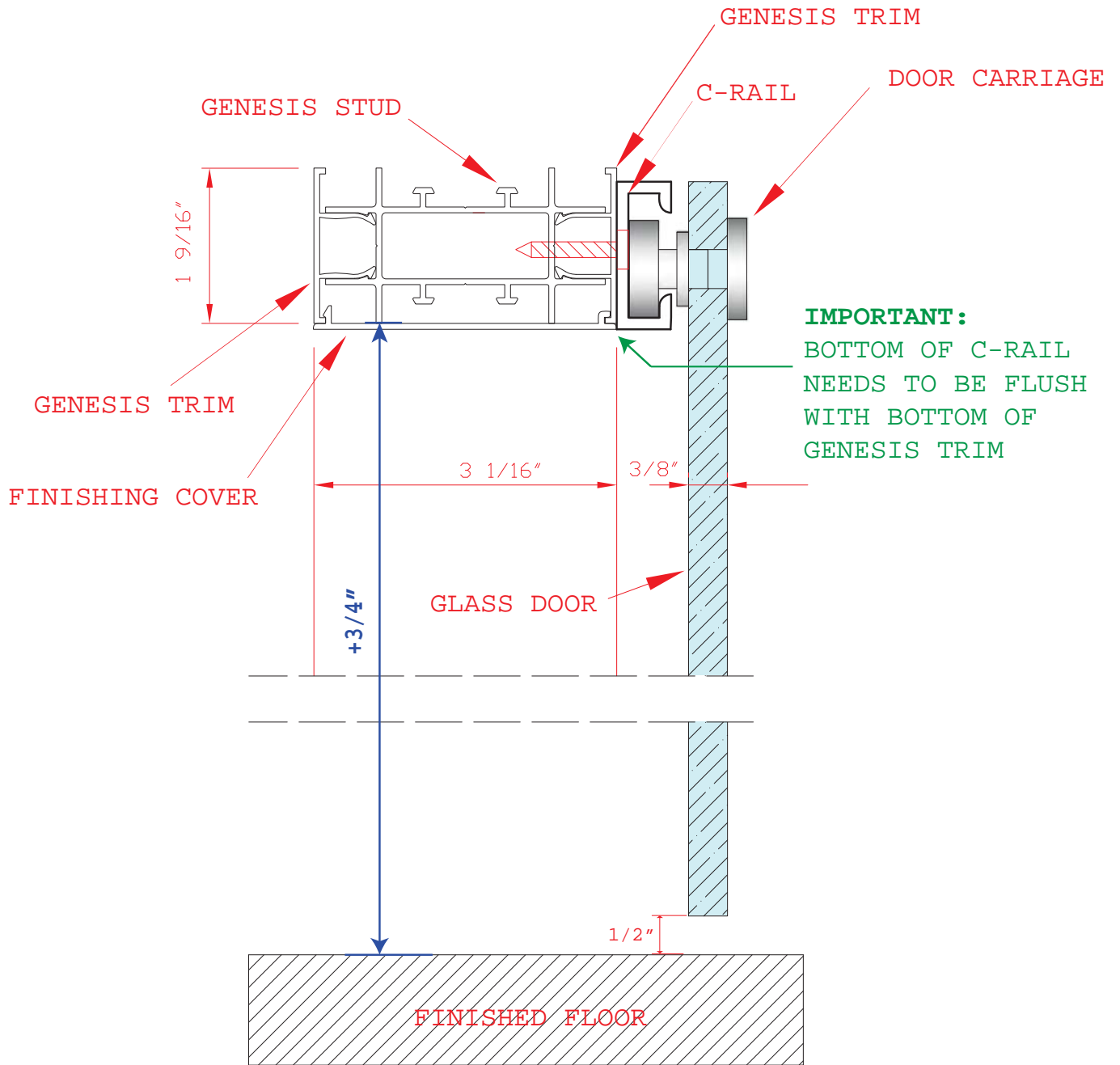

GLASS DOOR MEASUREMENT FOR C-RAIL:
MEASURE FROM THE BOTTOM FIN OF THE GENESIS STUD
TO THE TOP OF FINISHED FLOOR,
THEN **ADD $\frac{3}{4}"$**

C-RAIL GLASS DOOR MEASUREMENT (FLEX STUD)

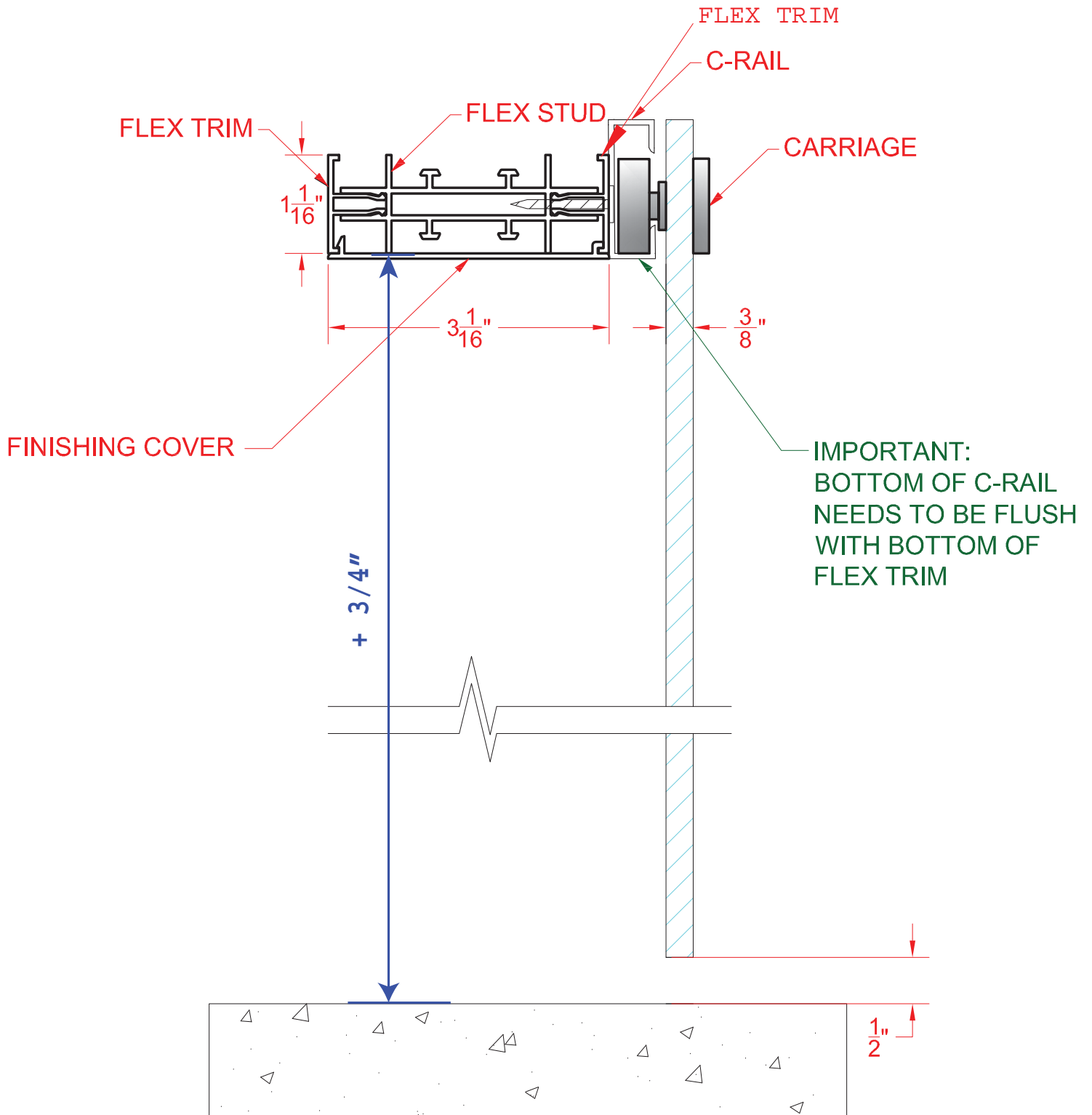

GLASS DOOR MEASUREMENT FOR C-RAIL:
 MEASURE FROM THE BOTTOM FIN OF THE FLEX STUD
 TO THE TOP OF FINISHED FLOOR,
 THEN **ADD $\frac{3}{4}$ "**