



VIEW SERIES GLASS MEASURING GUIDE

Phone Number: (269) 488-2752

Nxtwall

View Series Glass Measuring Guide



Phone: (269) 488-2752

01/2024

View Series Glass Measuring Guide

- This measuring guide applies to all View Series glass measuring situations.

General Notes for Measuring Glass

- All glass **MUST** be measured per the glass measuring guide. Make sure to measure for the correct situation for each piece of glass.
- When submitting dimensions make sure to submit final measurements. The final measurements include the additions and/or the subtractions to the measurements taken.
- Record all dimensions on the provided Glass Order Form.
 - When labeling the glass it is required to use the Partition number as part of the label. Example: P1-1, P1-2, P2-1, etc.
 - When recording the dimensions make sure the dimensions are legible. An electronic copy of the Glass Order Form is available on our website in the "Nxtwall Installation Resources" location.
- If there are any questions when measuring for glass contact Nxtwall.

Glass Delivery

- On the Glass Order Form include the delivery location, contact name, and phone number.
- When ordering glass the delivery method will need to be selected. There are two delivery options:
 - **Loose:** Quickest lead time. Glass will be delivered via route truck. Delivery times are non-guaranteed, a time frame will be provided (i.e. delivery between 8am-10am).
 - **Crated:** Longer lead times. Glass to be delivered via LTL or Private Truck. Must have ability to unload crate (i.e. forklift/loading dock).
- Approximate glass lead times are 7-10 business days from the date of the glass order.

Receiving Glass and Inspection

- When the glass is received the receiver is responsible for confirming the quantity received is correct and the dimensions are correct.
- The receiver will be responsible for reporting any damaged or defective glass. Glass defects are subject to the ASTM Glass Standards.
- Any glass issues must be reported within three business days of the glass delivery. Any reports outside of the three business days may be subject to additional fees.

Nxtwall

View Series Glass Measuring Guide

View Series Glass Measuring: Glass Height Measurement – Fixed Panes

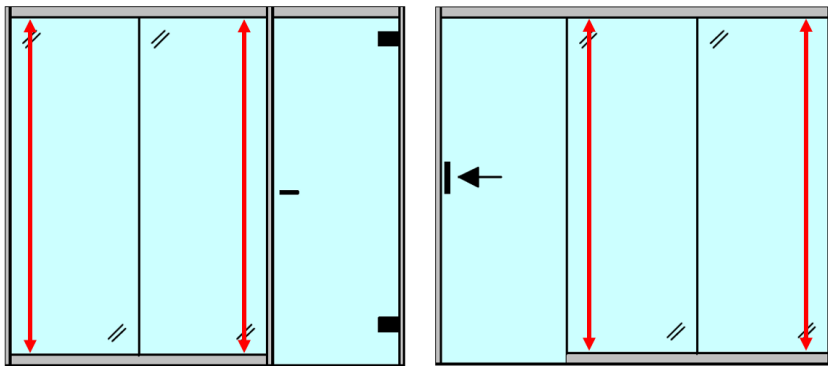

Measuring situation as shown on elevation

- Measurement Notes:
- The height measurement is the same for all measuring situations.
 - Measure the height at multiple locations within the opening to verify the height.
 - The heights should be the same across the opening.
 - Install 3/4" Shims into the View Track at the Floor.

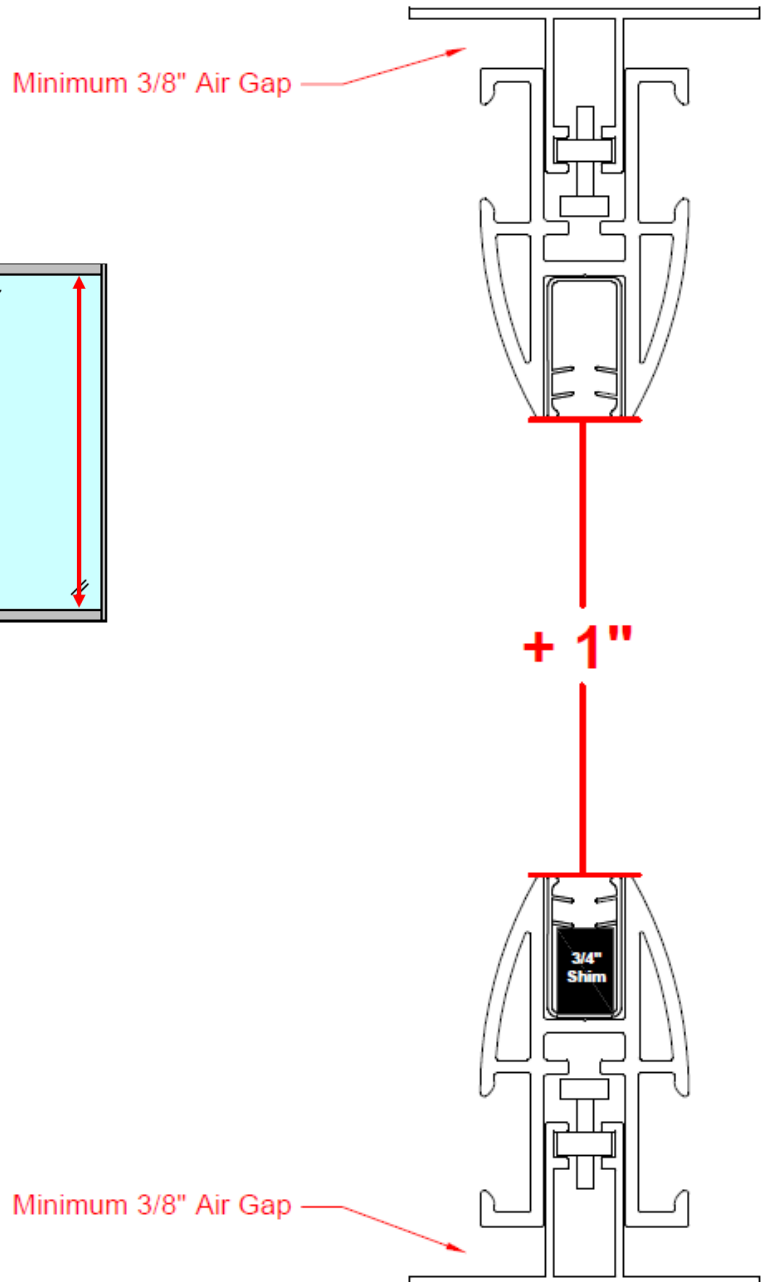

Glass Height Measurement:

Visual Opening Add 1"

****Measurement Location Shown****

Nxtwall View Series Glass Measuring Guide

View Series Glass Measuring: Glass Width Measurement for 2-6 Panes

- Wall-Start to Wall-Start

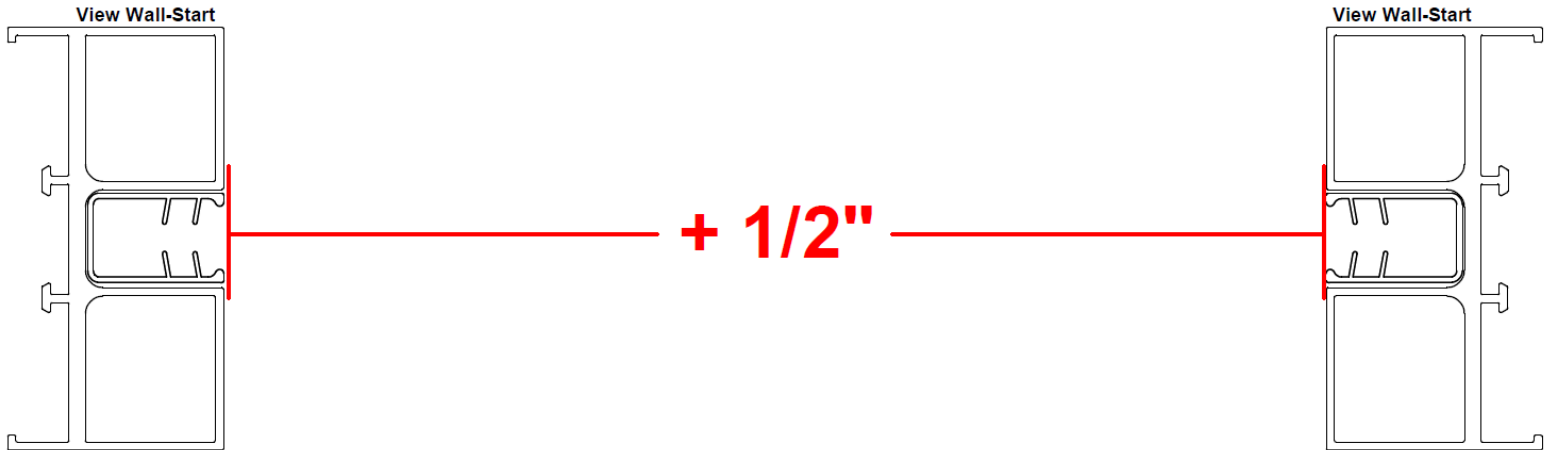

Glass Width Measurement for 2 - 6 Fixed Panes:

Visual Opening Add 1/2"

Measurement Location Shown

***Note: If there are more than 6 fixed panes of glass in a partition contact Nxtwall for measurement.**

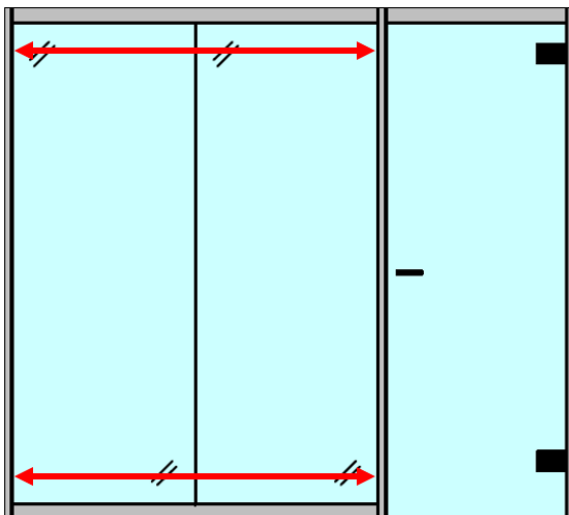

Measuring situation as shown on elevation

Measurement Notes:

- Divide the width measurement by the number of panes shown on the elevation.
 - Example: If there are 4 panes of glass in a partition and the VO is 96" add 1/2" for a 96 1/2" glass width. Divide 96 1/2" by 4 which will equal 4 panes of glass at a 24 1/8" width.
- The width measurement should be the same at the top and bottom of the opening.

Nxtwall View Series Glass Measuring Guide

View Series Glass Measuring: Glass Width Measurement

- Wall-Start to End of View Track

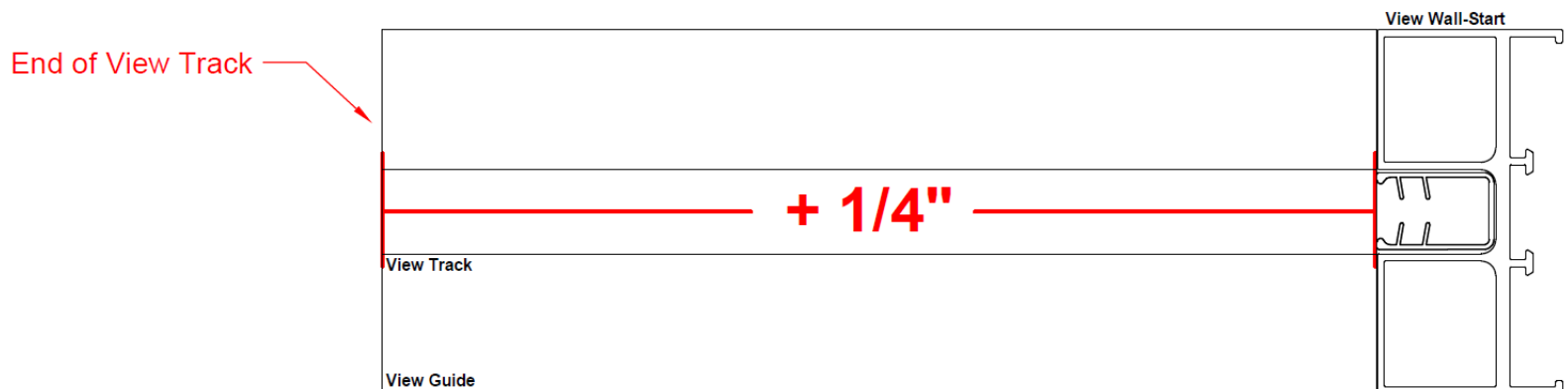

Glass Width Measurement for 1 - 6 Fixed Panes:
End of View Track to Wall-Start Add 1/4"
****Measurement Location Shown****

***Note: If there are more than 6 fixed panes of glass in a partition contact Nxtwall for measurement.**

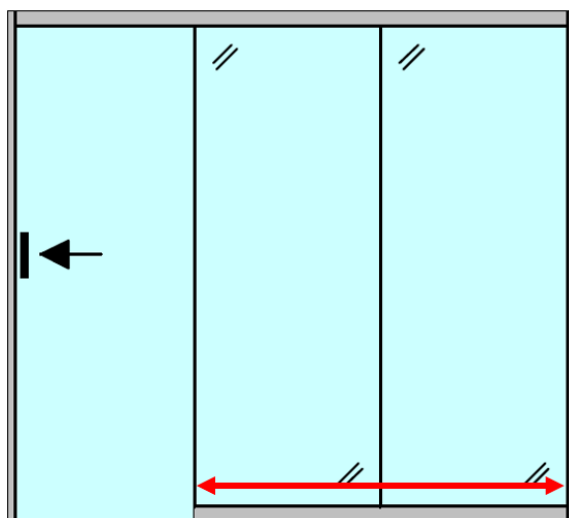

Measuring situation as shown on elevation

Measurement Notes:

- Divide the width measurement by the number of panes shown on the elevation.
 - Example: If there are 4 panes of glass in a partition and the VO is 96" add 1/4" for a 96 1/4" glass width. Divide 96 1/4" by 4 which will equal 4 panes of glass at a 24" width.
- The width measurement should be the same at the top and bottom of the opening.

Nxtwall View Series Glass Measuring Guide

View Series Glass Measuring: Glass Width Measurement – Single Sidelight

- One pane of glass between two View Wall-Starts

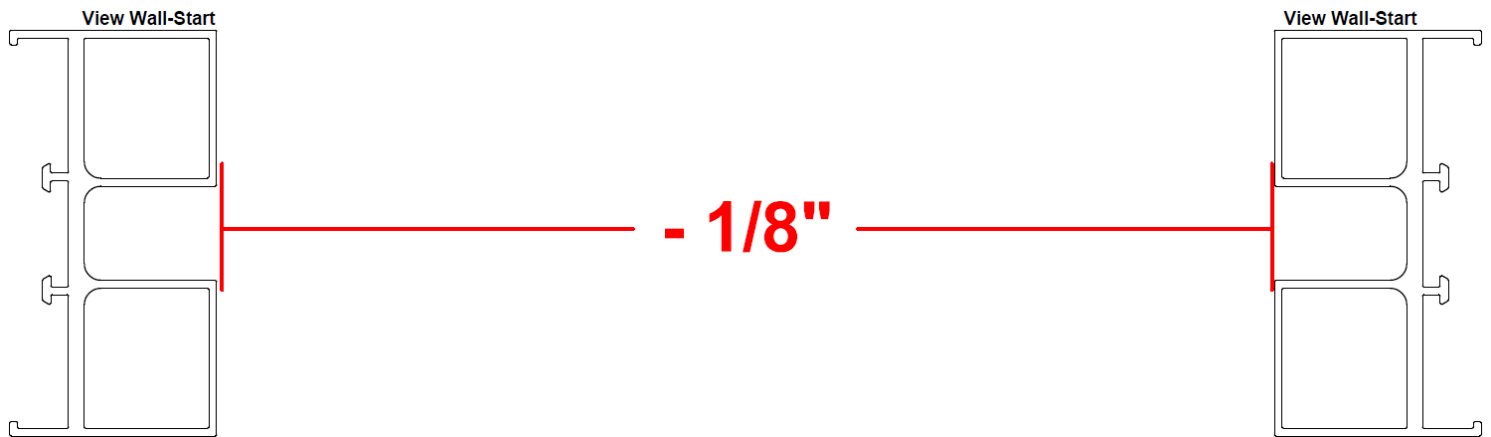

Glass Width Measurement for Single Sidelight (1) Fixed Pane:

Visual Opening Subtract 1/8"

****Measurement Location Shown****

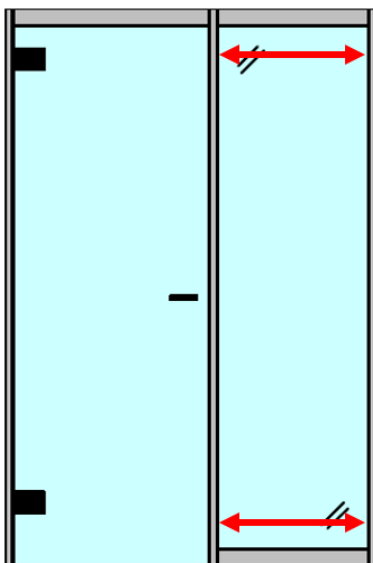

Measuring situation as shown on elevation

Measurement Notes:

- Reference "View Series Single Sidelight Installation" for proper installation of the framing and glass for Single Sidelight situations.
- The width measurement should be the same at the top and bottom of the opening.
- The height measurement is the same for Single Sidelights as if there were multiple panes of glass.

Nxtwall

View Series Glass Measuring Guide

View Series Glass Measuring: Sliding Door – Height Measurement

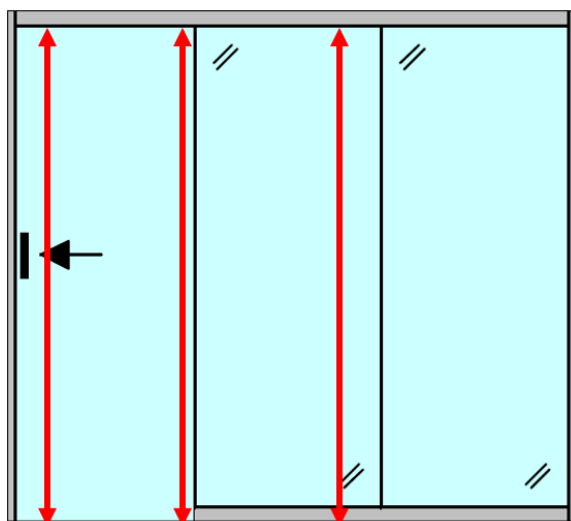

Measuring situation as shown on elevation

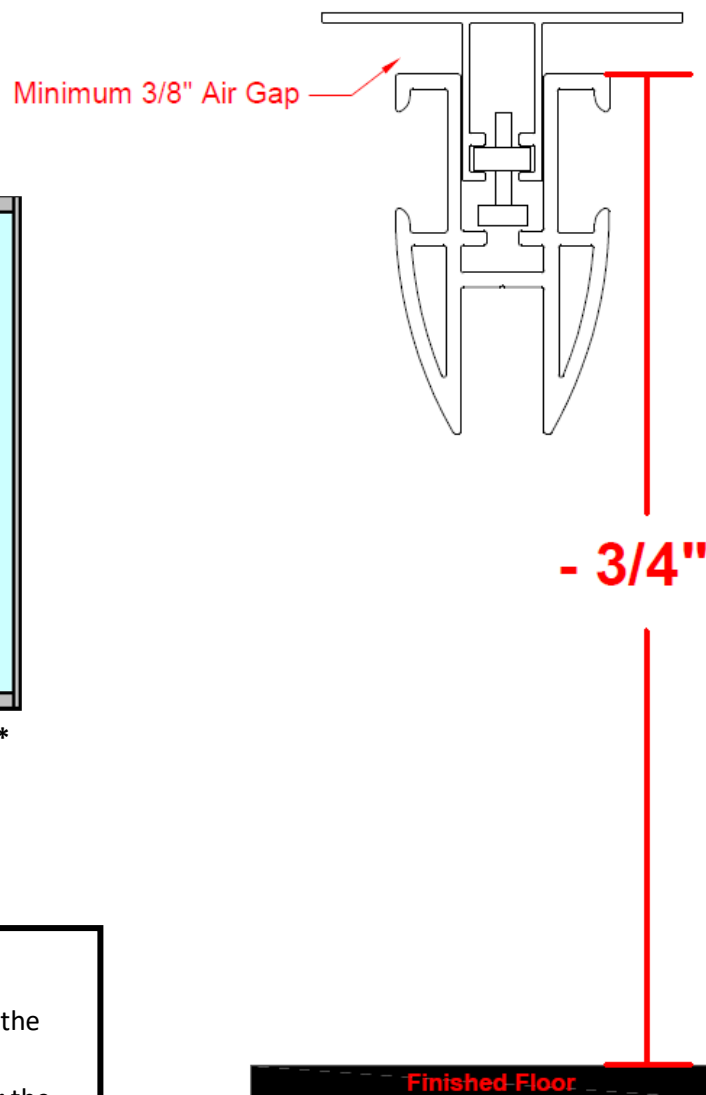

Measurement Notes:

- Measure the height at 2-3 locations along the door opening to verify the height.
 - Use the shortest measurement for the door height. This will ensure the door does not contact the floor when opening and closing.
- With a 38" walkthrough opening the standard width for Sliding Glass Doors is 42".

Glass Sliding Door Height Measurement:
Finished Floor to Top of View Track Subtract 3/4"
****Measurement Location Shown****

Nxtwall

View Series Glass Measuring Guide

View Series Glass Measuring: Single Glass Swing Door – Width Measurement

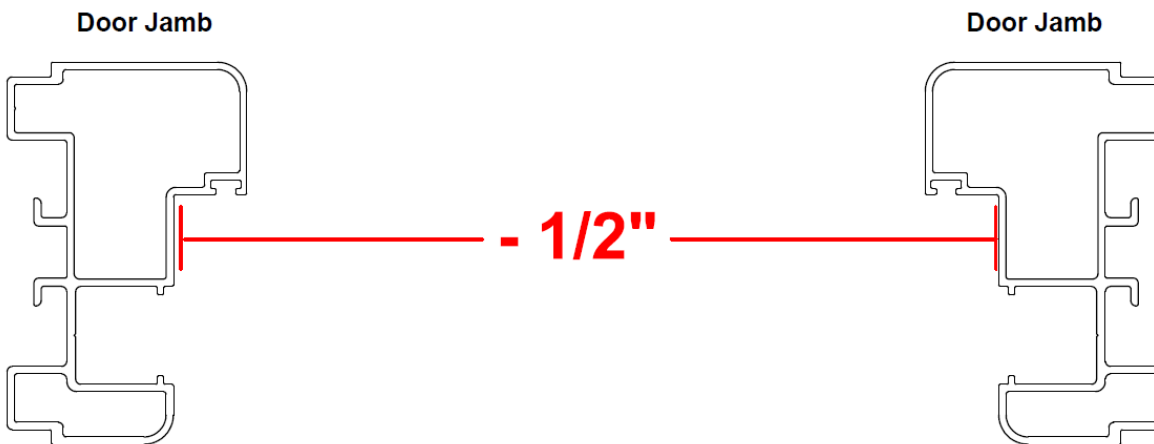

Single Glass Swing Door Width Measurement:
Door Jamb to Door Jamb Subtract 1/2"
Measurement Location Shown

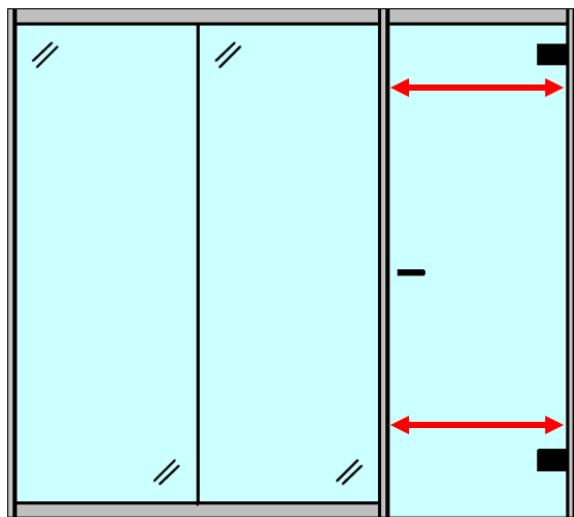

Measuring situation as shown on elevation

Measurement Notes:

- Measure the width at multiple locations within the opening to verify width.
 - The width must be the same from top to bottom to ensure proper fitment.
- For standard Single Swing Doors the width is typically 35 1/2" or 35 5/8".

Nxtwall View Series Glass Measuring Guide

View Series Glass Measuring: Glass Swing Door – Height Measurement

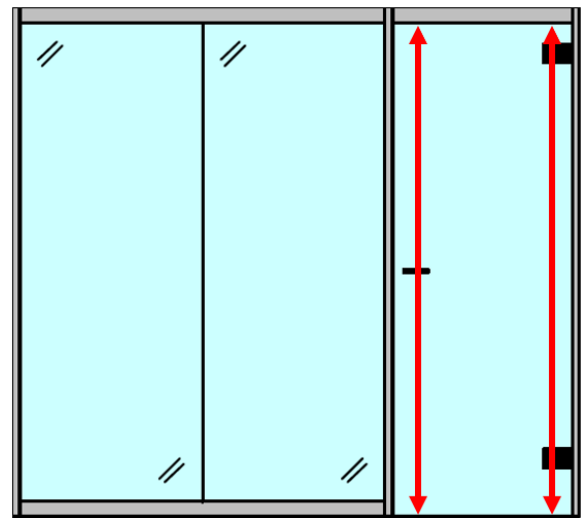
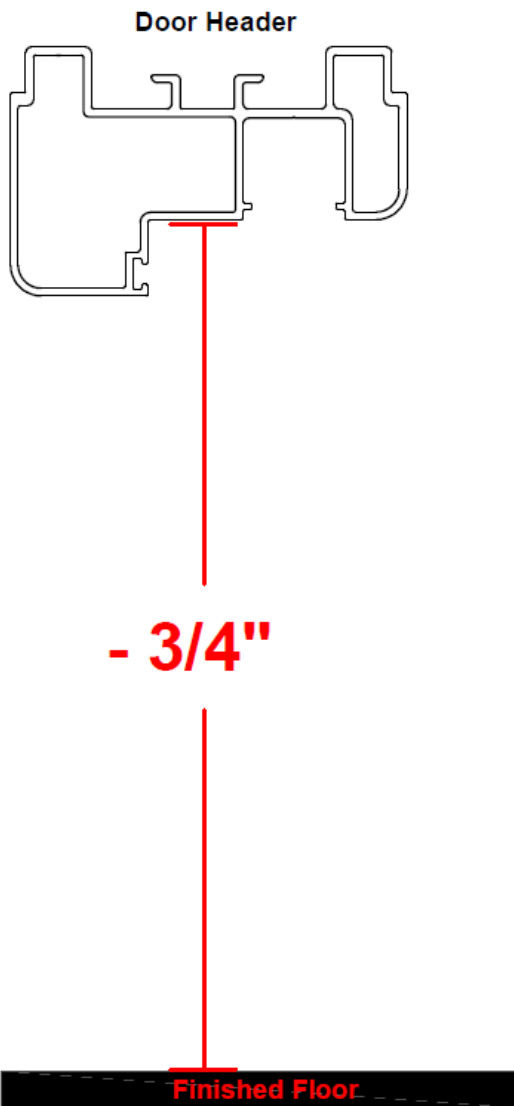

Measuring situation as shown on elevation

Measurement Notes:

- Measure the height on each side of the opening to verify height.
 - Use the shortest measurement for the door height.
- The height measurement calculation allows a 1/2" air gap at the floor and a 1/4" air gap between the top of the door and door header.

Glass Swing Door Height Measurement:
Finished Floor to Door Header Subtract 3/4"

****Measurement Location Shown****

Nxtwall View Series Glass Measuring Guide

View Series Glass Measuring: Double Glass Swing Door – Width Measurement

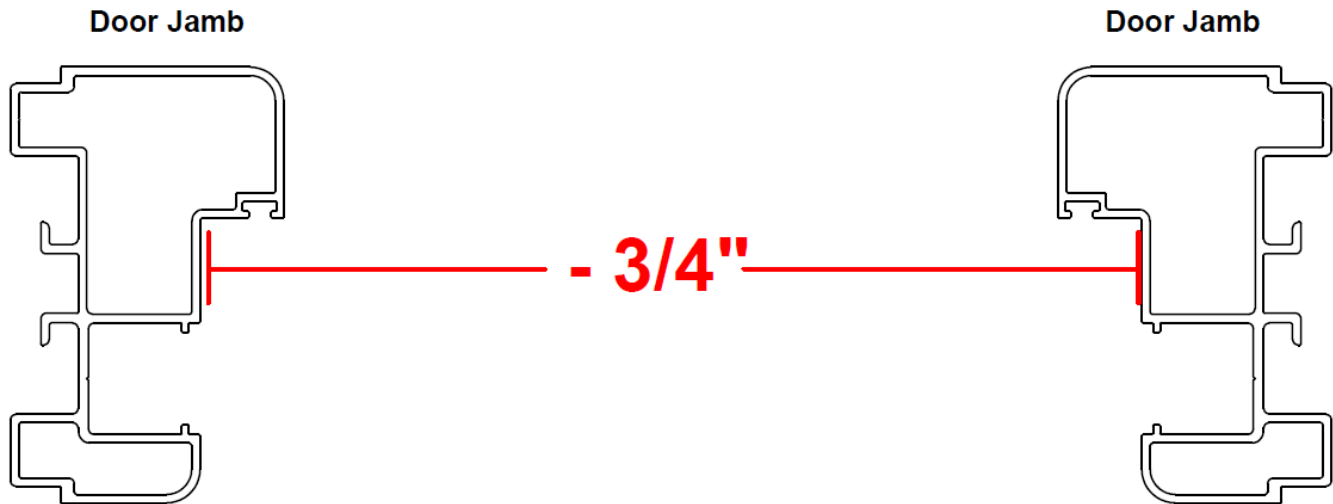

Double Glass Swing Door Width Measurement:

Door Jamb to Door Jamb Subtract 3/4"

Divide Measurement by 2 for Individual Door Width

Measurement Location Shown

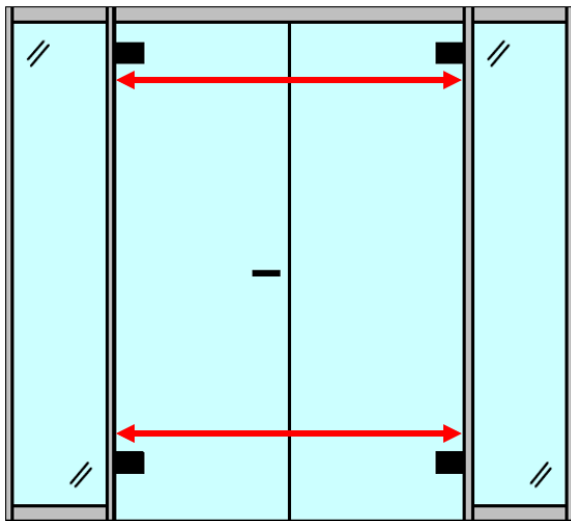

Measurement Notes:

- Measure the width at multiple locations within the opening to verify width.
 - The width must be the same from top to bottom to ensure proper fitment.
- Measurement will provide approximately 1/4" Gap between doors.

Measuring situation as shown on elevation

Nxtwall View Series Glass Measuring Guide

View Series Glass Measuring: Double Glass Swing Door – Height Measurement

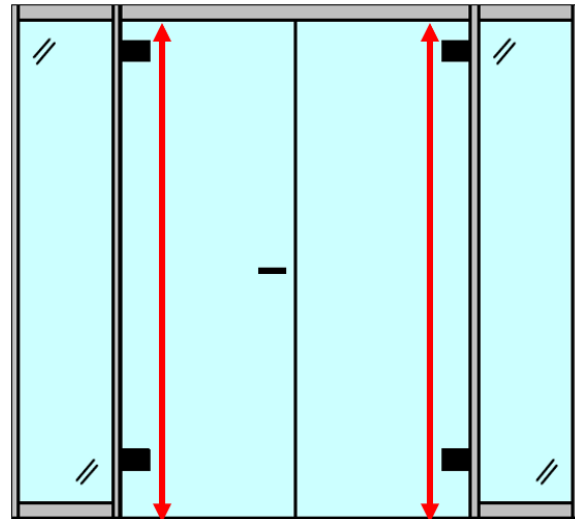
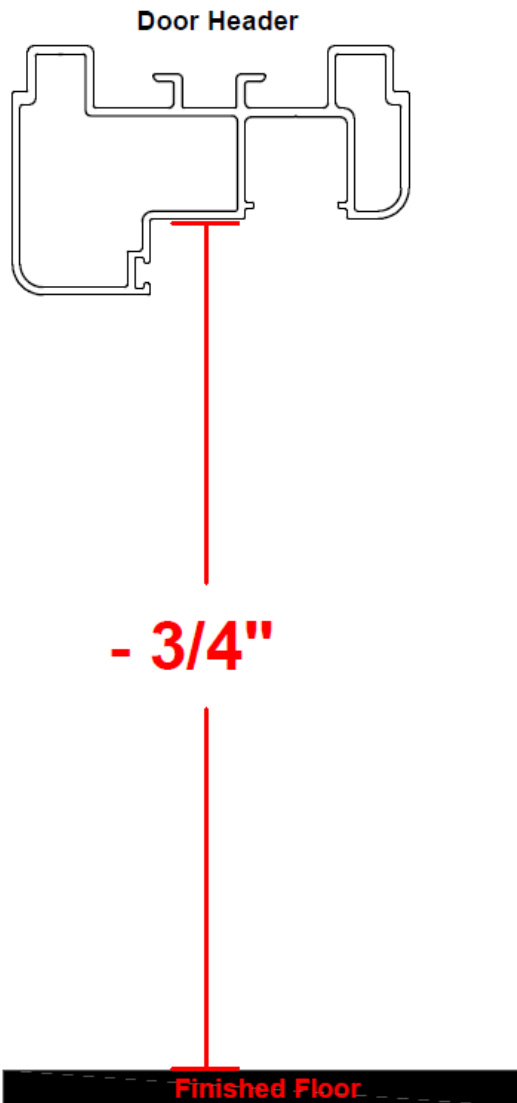

Measuring situation as shown on elevation

Measurement Notes:

- Measure the height at 2-3 locations within the door opening to verify the height.
 - Use the shortest measurement for the door heights.
- It is important for door heights to match for the door handles to align with each other properly.
- The height measurement calculation allows a 1/2" air gap at the floor and a 1/4" air gap between the top of the door and door header.

Glass Swing Door Height Measurement:
Finished Floor to Door Header Subtract 3/4"

****Measurement Location Shown****

Nxtwall

View Series Glass Measuring Guide

View Series Glass Measuring: Double Glass Sliding Door – Height Measurement

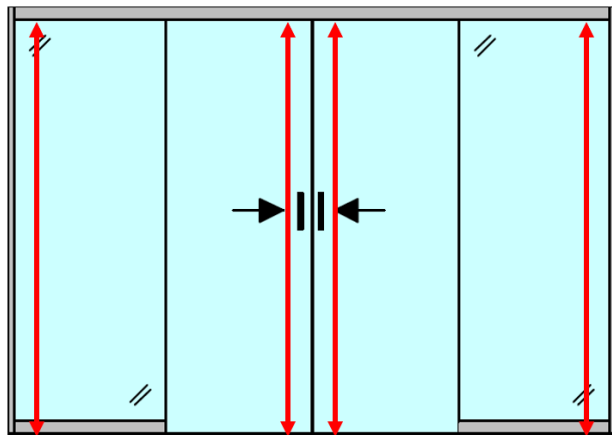

Measuring situation as shown on elevation

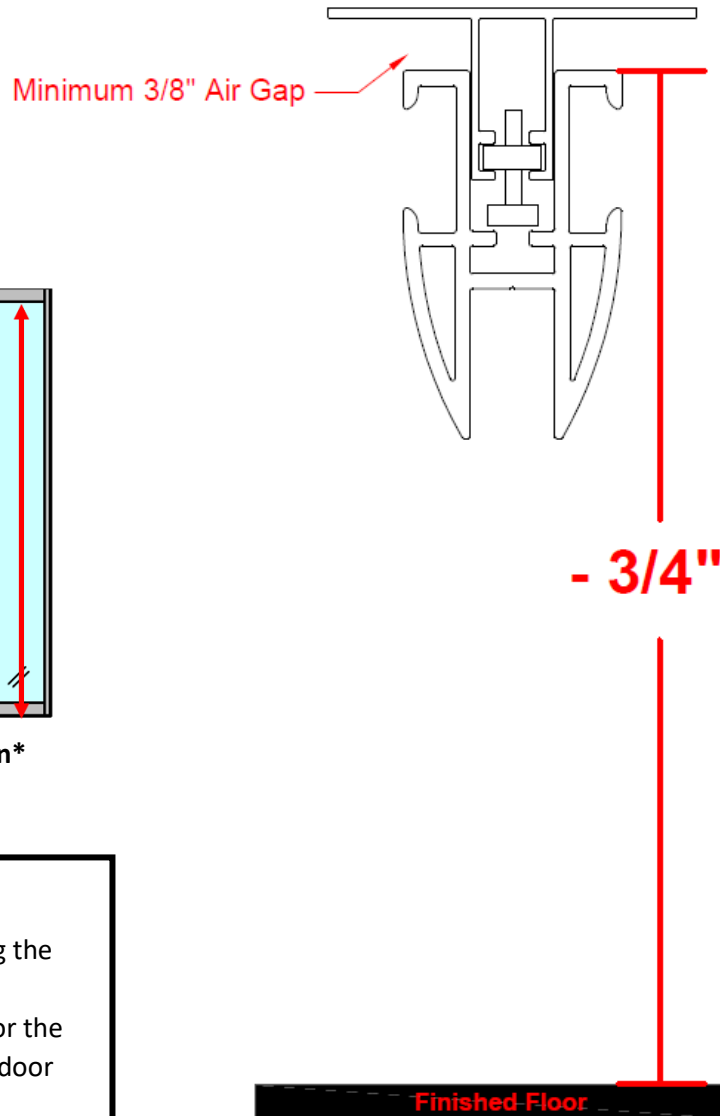

Measurement Notes:

- Measure the height at 2-3 locations along the door opening to verify the height.
 - Use the shortest measurement for the door height. This will ensure the door does not contact the floor when opening and closing.
- The doors will need to be the same height to ensure the handles align properly.
- With a 38" walkthrough opening the standard width for Sliding Glass Doors is 42".

Glass Sliding Door Height Measurement:
Finished Floor to Top of View Track Subtract 3/4"

****Measurement Location Shown****

Nxtwall View Series Glass Measuring Guide

View Series Glass Measuring: Seamless 90° Corner – Width Measurement

Glass Width Measurement for Single (1) Fixed Pane:
Wall-Start to Inside Edge of View Track Add 1/2"
Measurement Location Shown

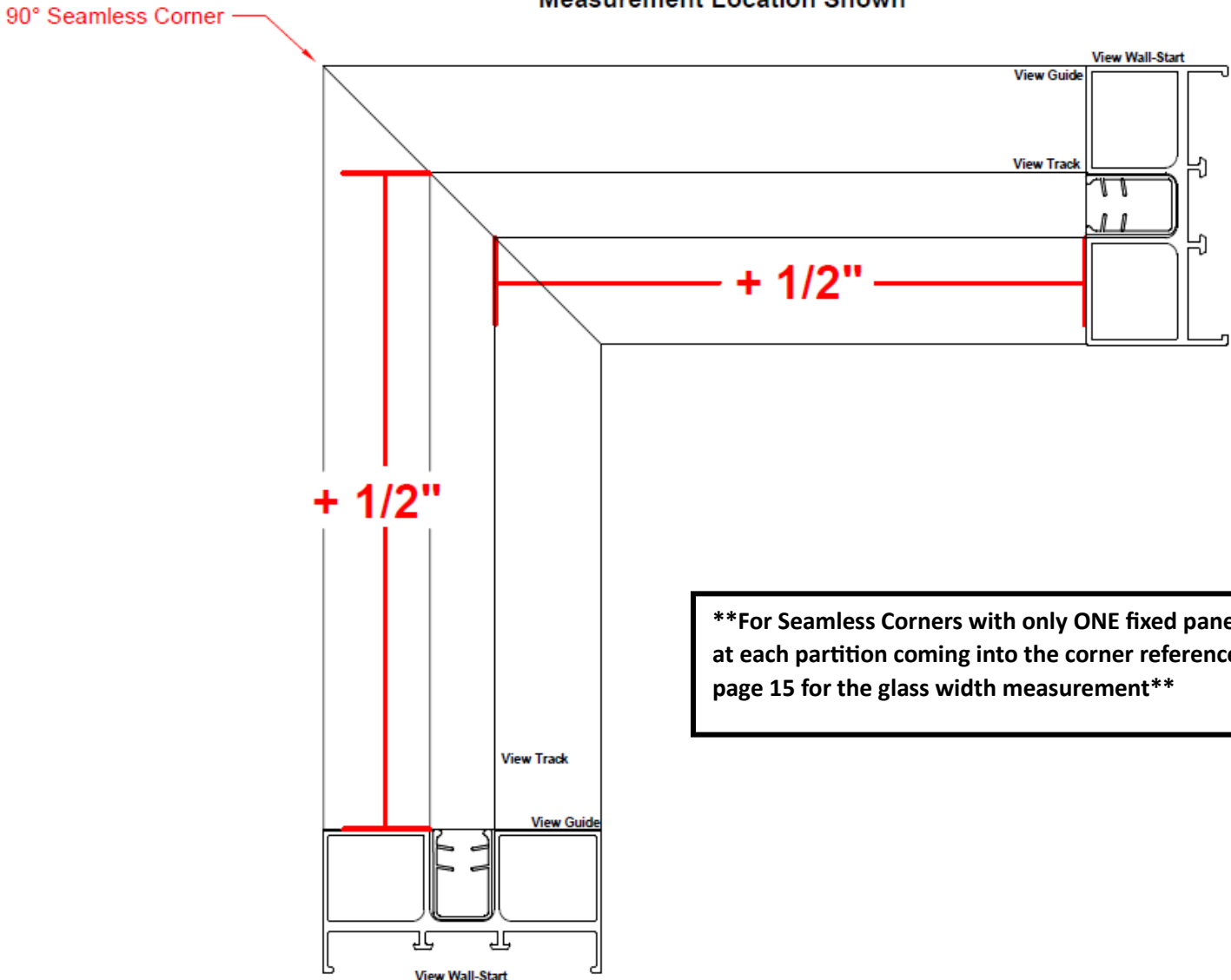

****For Seamless Corners with only ONE fixed pane at each partition coming into the corner reference page 15 for the glass width measurement****

Glass Width Measurement for 2-6 Fixed Panes:
Wall-Start to Outside Edge of View Track Add 1/2"
Measurement Location Shown

*Note: If there are more than 6 fixed panes of glass in a partition contact Nxtwall for measurement.

Nxtwall

View Series Glass Measuring Guide

View Series Glass Measuring: Wingback – Width Measurement

Glass Width Measurement for 2 - 6 Fixed Panes:

Visual Opening Add 1/2"

Measurement Location Shown

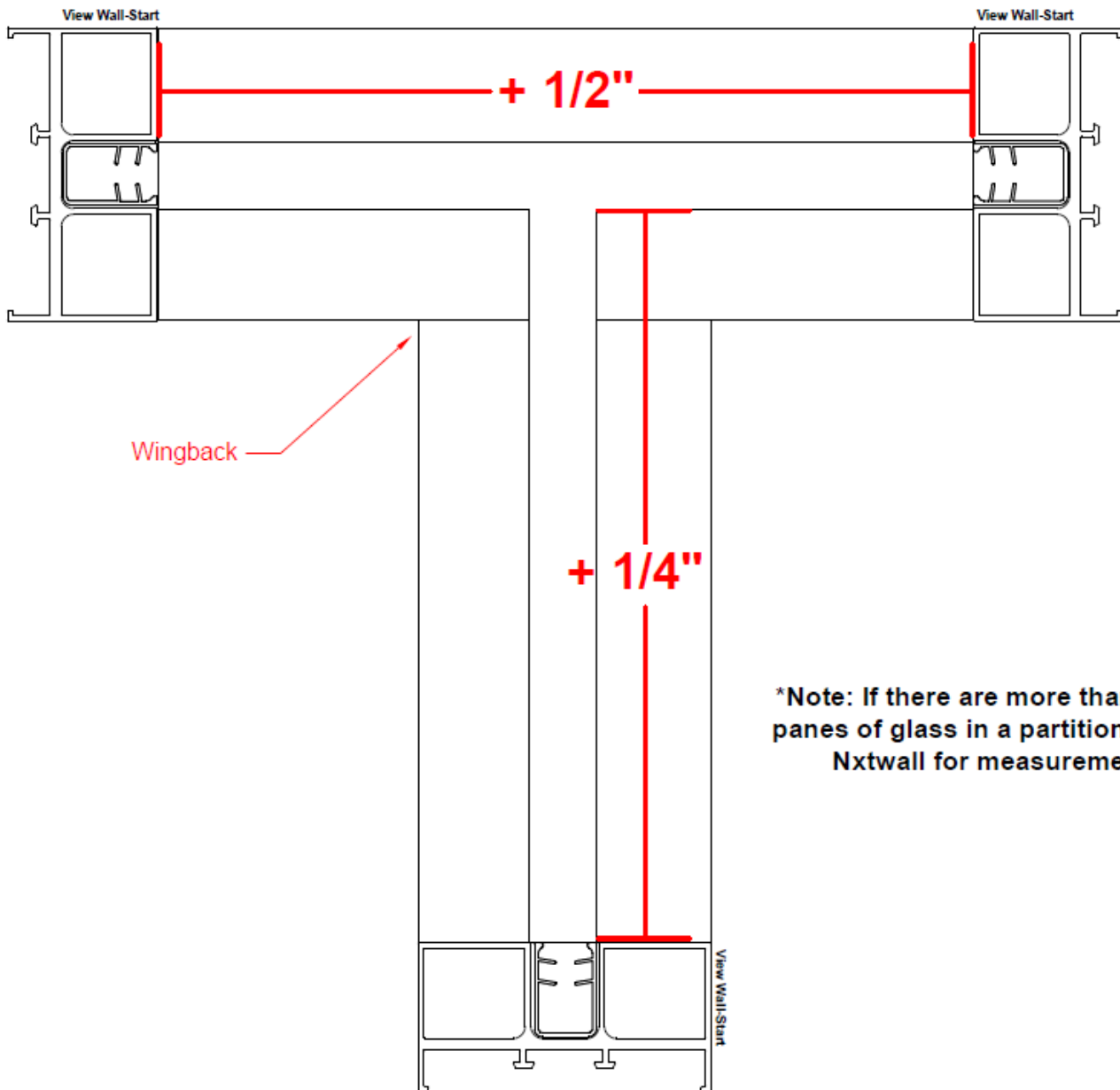

Note: If there are more than 6 fixed panes of glass in a partition contact Nxtwall for measurement.

Glass Width Measurement for Wingback Fixed Panes:

Wall-Start to Inside Edge of View Track Add 1/4"

Measurement Location Shown

Nxtwall

View Series Glass Measuring Guide

View Series Glass Measuring: Seamless 90° Corner – Width Measurement – Single Pane of Glass on Each Corner

90° Seamless Corner

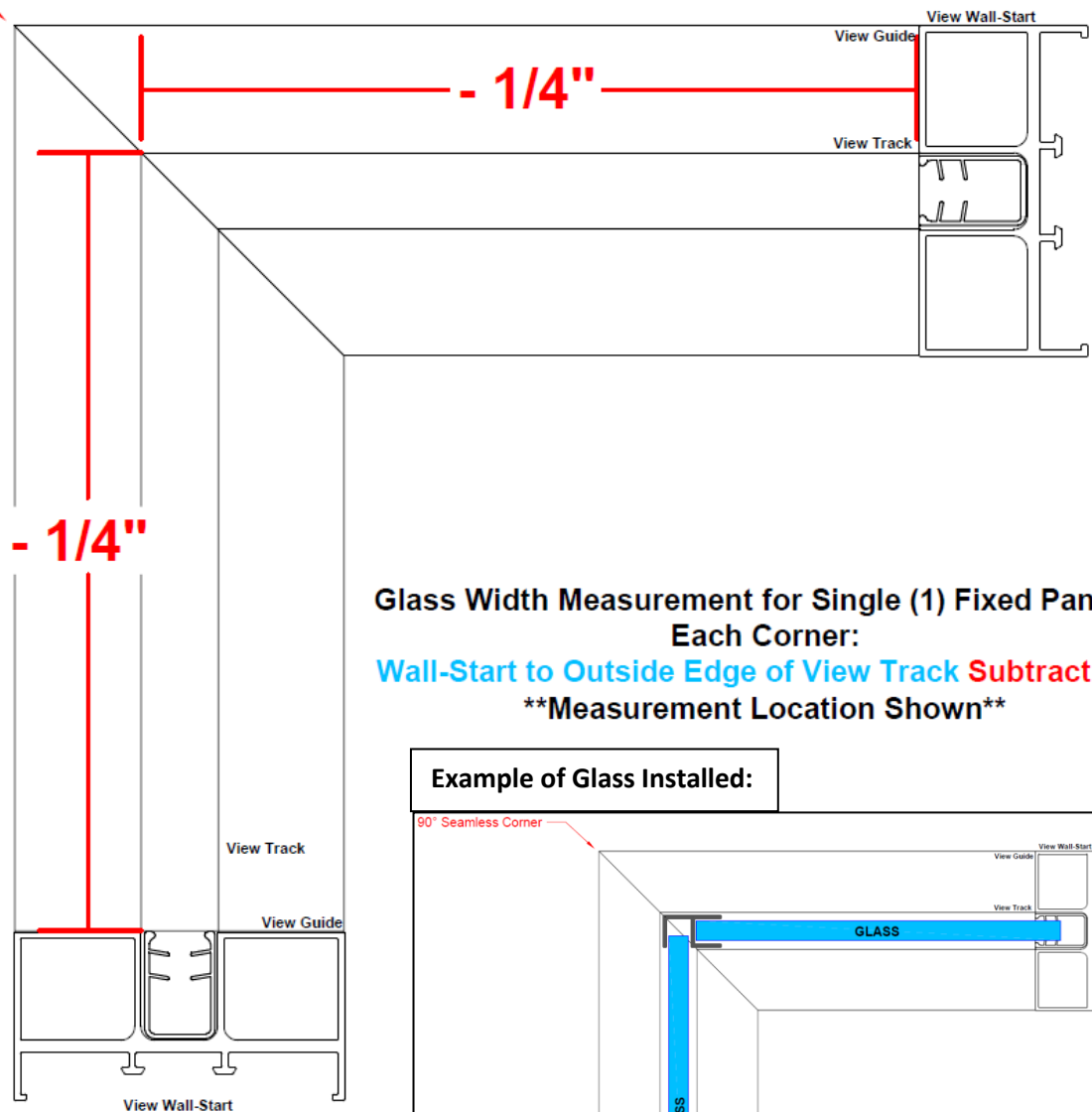

Glass Width Measurement for Single (1) Fixed Pane on Each Corner:
Wall-Start to Outside Edge of View Track Subtract $1/4"$
****Measurement Location Shown****

Example of Glass Installed:

